

**OWNER'S MANUAL**

**DX-394  
Communications Receiver**

Please read before using this equipment.

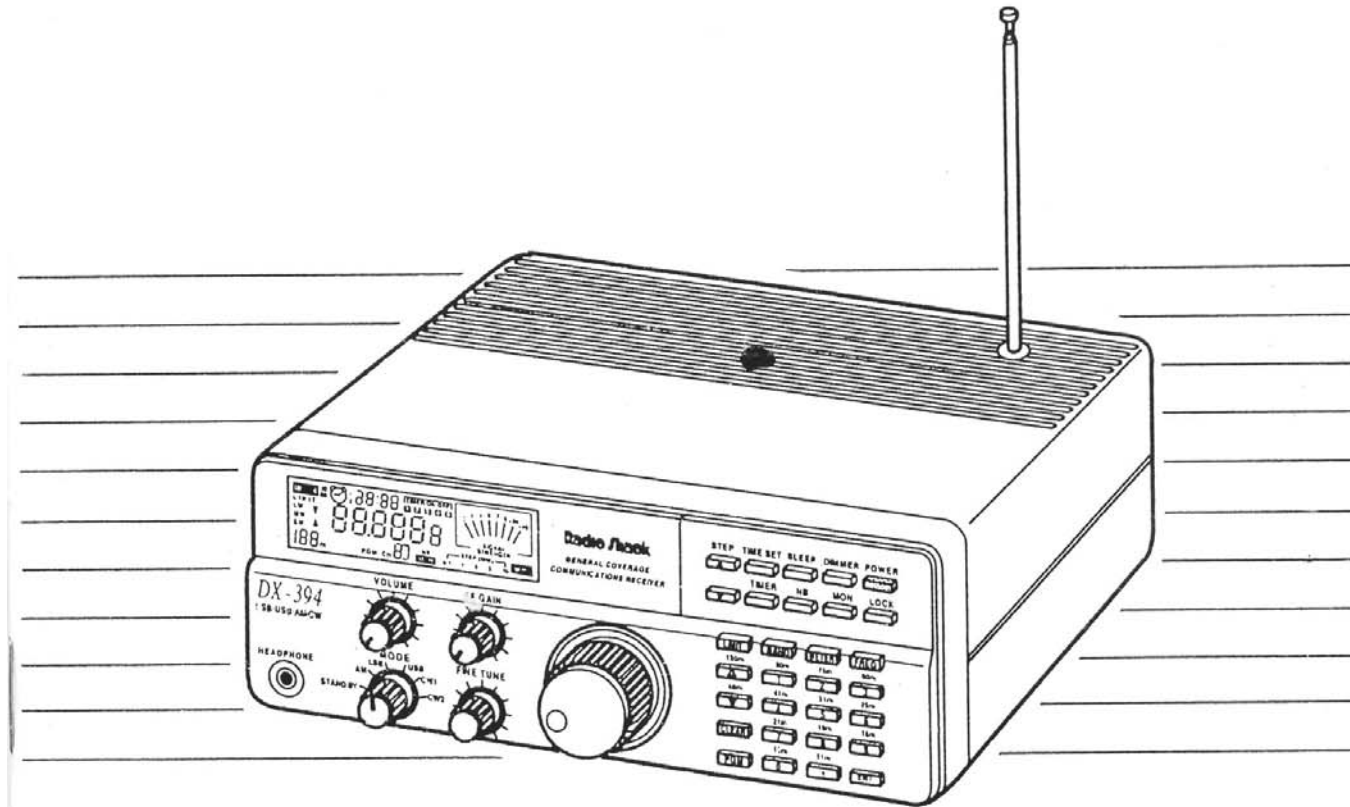

**Radio Shack®**

## INTRODUCTION

Your Radio Shack DX-394 Communications Receiver brings the voices of the world to you. In the 13 international short wave (SW) bands, you can hear news broadcasts and other programs from sources such as Radio Japan, the British Broadcasting Corporation, Radio Moscow, and Radio Peking.

You can get emergency information firsthand by listening to ham radio communication, including single sideband (SSB) voice transmissions and continuous wave (CW) Morse code transmissions.

In the long wave (LW) band, you can hear ship-to-shore calls, other marine and aeronautical services, and sometimes even hurricane reports.

You can tune to local broadcasts in the medium wave (MW) bands. (In the United States, we commonly call the MW band the AM band.)

Your receiver has these special features:

**PLL Synthesized Receiver** — ensures accurate, stable tuning.

**Large, Liquid Crystal Display** — shows the time, band and frequency, signal strength, and other indicators.

**Five Programmable Timers** — let you store frequencies and on/off times for automatic listening pleasure.

**Tape Out Jack** — lets you connect an optional tape recorder.

**Dual Time** — includes a primary clock and a secondary clock, so you can set one to your local time, and the other to UTC (Coordinated Universal Time — also known as Greenwich Mean Time) or to the local time of a city in another time zone.

**Search Tuning** — scans up or down the band for the next available station.

**Memory Tuning** — stores up to 160 frequencies so you can quickly select your favorite stations.

**Direct Access Tuning** — tunes to the frequency you enter on the keypad.

**Rotary Tuning Adjustment** — lets you manually tune desired frequencies or channels.

**Lock** — prevents you from accidentally changing the band or frequency, changing the clock settings, or turning on or off the timer.

**MW Step Setting** — lets you easily change the frequency step setting to match MW (AM) broadcast frequencies used by many other countries.

**RF Gain Control** — sets the receiver's sensitivity.

**Headphones Jack** — lets you connect a pair of headphones.

**External Speaker Jack** — lets you connect an external speaker.

**Dual Conversion Upper Superheterodyne** — eliminates any interference from IF (Intermediate Frequency) images, so you only hear the selected frequency.

**Monitor Memory** — lets you temporarily save a frequency.

**Two Antenna Jacks** — lets you use high- and low-impedance antennas.

**ATT Switch** — reduces the receiver's sensitivity to strong local signals when using a low impedance antenna connector.

**Memory Backup** — replacement-free rechargeable lithium battery keeps channels stored in memory for more than 1 month during a power loss.

**Two Power Options** — lets you power the receiver from standard AC power or from your vehicle's battery (with an optional DC cigarette lighter power cable).

For your records, please record your receiver's serial number in the space provided. The serial number is located on the back of the receiver.

Serial Number \_\_\_\_\_

**Warning:** To prevent fire or shock hazard, do not expose this receiver to rain or moisture.

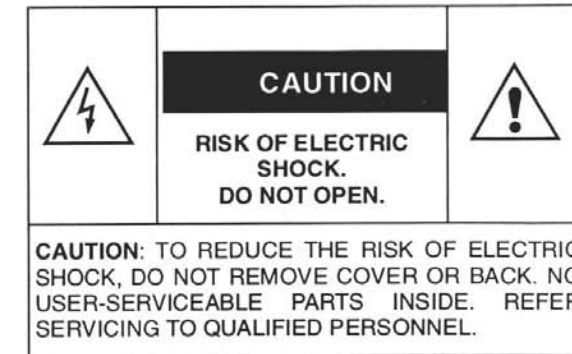

This symbol is intended to alert you to the presence of uninsulated dangerous voltage within the receiver's enclosure that might be of sufficient magnitude to constitute a risk of electric shock. Do not open the receiver's case.



This symbol is intended to inform you that important operating and maintenance instructions are included in the literature accompanying this receiver.

© 1995 InterTAN Inc.  
All Rights Reserved.

Radio Shack is a registered trademark used by Tandy Corporation.

Your DX-394 receiver is preset to cover the following bands:

Band	Frequency Range
LW	150—509.9 kHz
MW (AM)	510—1729.9 kHz
SW	1.73—29.9999 MHz

Band (in meters)	Frequency Range
120	2.300—2.495 MHz
90	3.200—3.400 MHz
75	3.900—4.000 MHz
60	4.750—5.060 MHz
49	5.950—6.200 MHz
41	7.100—7.300 MHz
31	9.500—9.900 MHz
25	11.650—12.050 MHz
21	13.600—13.800 MHz
19	15.100—15.600 MHz
16	17.550—17.900 MHz
13	21.450—21.850 MHz
11	25.670—26.100 MHz

## NOTICE

Your receiver might cause radio or TV interference, even when it is operating properly. To determine whether or not your receiver is causing the interference, turn off your receiver. If the interference goes away, your receiver is causing it. Try to eliminate the interference by:

- Moving your receiver away from the other receiver
- Connecting your receiver to an outlet that is on a different electrical circuit from the other receiver
- Contacting your local Radio Shack/Tandy store for help

If you cannot eliminate the interference, local laws may require you to stop using your receiver.

This device complies with North American regulations. Operation is subject to the following conditions: (1) This device must not cause harmful interference, and (2) this device must accept any interference received, including interference that may cause undesired operation.

## CONTENTS

<b>Preparation</b> .....	<b>7</b>
The Antenna .....	7
Grounding .....	8
Connecting Power .....	8
Connecting AC Power .....	8
Using Your Vehicle's Battery .....	9
Resetting the Receiver .....	9
Connecting Headphones .....	10
Listening Safely .....	10
Connecting an External Speaker .....	10
Connecting a Tape Recorder .....	11
<b>Understanding Your Receiver</b> .....	<b>12</b>
A Look at the Controls .....	12
A Look at the Display .....	13
<b>Receiver Operation</b> .....	<b>14</b>
Using the Mode Control .....	14
Selecting the Band .....	15
Selecting the International Radio Frequency Band .....	15
Setting a Limit Tuning Range .....	15
Tuning to a Station .....	16
Manual Tuning .....	16
Direct Access Tuning .....	16
Search Tuning .....	16
Memory Tuning .....	17
Using a Monitor Memory .....	17
Using the RF Gain Control .....	18
Using the Fine Tune Control .....	18
Setting the Frequency Step .....	18
Changing the MW Tuning Increment .....	19
Using the Dimmer Button .....	19
Using the Lock Button .....	19
Using the ATT Switch .....	19

<b>Clock Radio Operation .....</b>	<b>20</b>
Setting the Clocks .....	20
Using the Timers .....	20
Programming a Timer .....	20
Turning on a Timer .....	22
Clearing a Timer .....	22
Using the Sleep Timer .....	22
<b>Listening Hints .....</b>	<b>23</b>
Reference Sources .....	23
Band Allocation .....	23
Ham Frequencies .....	23
Birdie Frequencies .....	24
International Broadcast Frequencies .....	24
Aircraft Frequencies .....	25
Ships and Coastal Stations .....	25
Time Standard Frequencies .....	25
Long Wave Band .....	25
Frequency Conversion .....	26
<b>Troubleshooting .....</b>	<b>27</b>
<b>Care and Maintenance .....</b>	<b>28</b>
<b>Specifications .....</b>	<b>29</b>

## PREPARATION

When you are deciding where to set up the receiver, you should consider:

**LOCATION.** You will spend many hours listening to your receiver; be sure it is placed where you can enjoy it at any time. This receiver is primarily designed for use in the home as a base station. You can place it on a desk, shelf, or table.

**ANTENNA.** For maximum performance, you need an optional, external long-wire antenna, such as a short wave antenna that will be mounted outside.

**GROUNDING.** For safety, you should connect a ground wire to the receiver. This requires running a ground wire from the ground screw connection on the back of the receiver to a ground connection, such as a metal cold water pipe or metal pipe driven into the earth.

Your receiver's front feet fold up or down. Adjust them to give you the best view of the display.

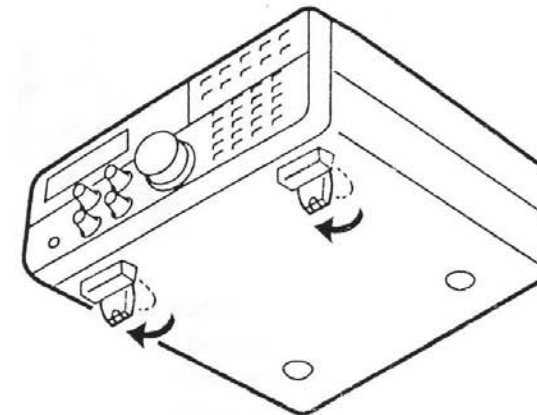

## THE ANTENNA

To attach the supplied telescoping antenna, simply screw it clockwise into the hole on the receiver's top.

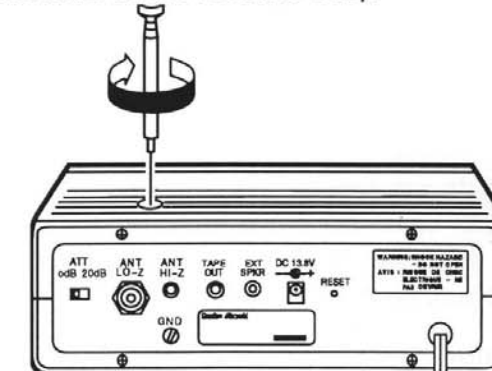

For the best reception, fully extend the antenna.

The telescoping antenna is adequate for strong local signals. However, if you use an external antenna, you can receive more, strong signals.

No single antenna covers the entire frequency range of the DX-394 efficiently, but there are many different types of antennas you can use. Your local Radio Shack/Tandy store sells a wide variety of antennas. Choose the one that best suits your needs.

For a simple, all-purpose antenna, use the long-wire type. The horizontal section of the antenna should be more than 10 meters (30 feet). Mount the antenna as high as possible (more than 5 meters (15 feet)) from the ground and away from power lines, buildings, and metal structures. Connect the antenna's phono plug to the **ANT HI-Z** jack on the back of the receiver.



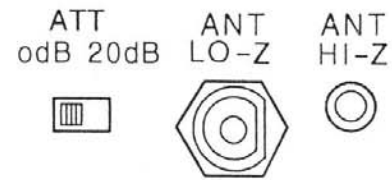

A dipole antenna is made up of two pieces of wire, each half of the total length. Connect the antenna's PL-259 plug to the **ANT LO-Z** jack on the back of the receiver.

**Caution:** Do not run the cable over sharp edges or moving objects.

**Warning:** Use extreme caution when you install or remove an outdoor antenna. If the antenna starts to fall, let it go! It could contact overhead power lines. If the antenna touches a power line, contact with the antenna, mast, cable, or guy wires can cause electrocution and death. Call the power company to remove the antenna. **DO NOT** attempt to do so yourself.

## GROUNDING

To insure the best reception, you must always connect a heavy gauge ground wire (not supplied) to the **GND** screw on the back of the receiver. Connect the other end either to a metal cold water pipe (not hot water and not natural gas pipe) or to a metal ground rod (not supplied) driven into the ground. Or, you can bury a copper plate or copper net in the ground and connect to it.

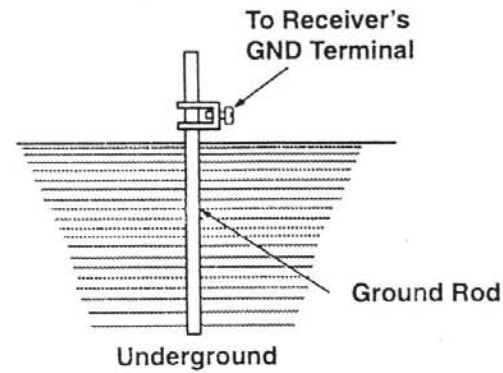

For more information about antennas and grounding, obtain a copy of "The ARRL Amateur Radio Handbook," available at your local Radio Shack/Tandy store.

## CONNECTING POWER

### Connecting AC Power

Plug the receiver's AC power cord into a standard AC outlet.

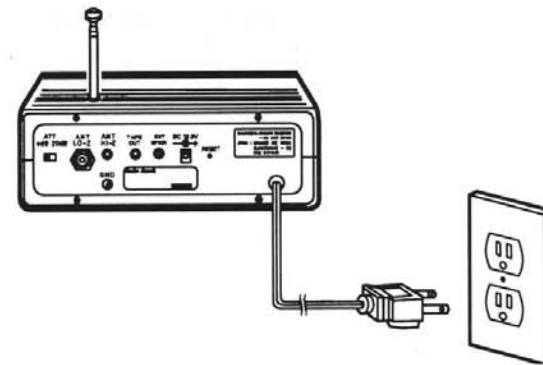

**Caution:** To prevent electric shock, the plug's blades are polarized and fit only one way. If the plug does not fit easily, turn it over and try again. Do not force the plug into the AC outlet.

## Using Your Vehicle's Battery

You can also power your receiver from your vehicle's cigarette lighter socket with an optional DC cigarette lighter power cable (not supplied).

**Caution:** You must use a DC cigarette lighter power cable that supplies 12 volts and delivers at least 500 mA. Its center tip must be set to positive and its plug must correctly fit the **DC 13.8 V** jack on the back of the receiver. The recommended power cable meets these specifications. Using a power cable that does not meet these specifications could damage the receiver or the power cable.

Insert the DC power cable's barrel plug into the **DC 13.8V** jack on the back of the receiver, then plug the power cable into your vehicle's cigarette lighter socket.

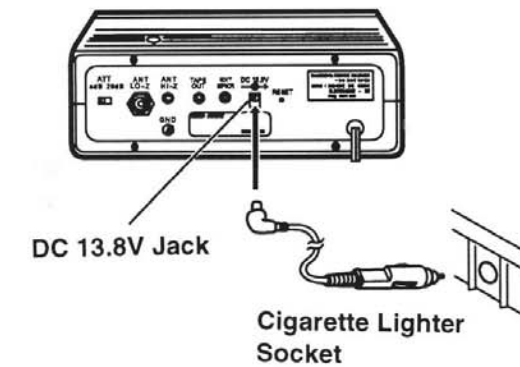

## RESETTING THE RECEIVER

If the receiver's display locks up or the receiver does not work properly after you connect power, you might need to reset the receiver.

**Caution:** This procedure clears all the information you have programmed into the receiver. Use this procedure only when you are sure your receiver is not working properly.

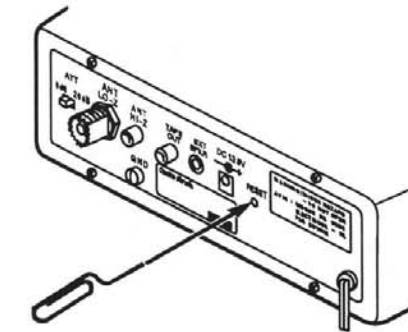

Insert a pointed object, such as a straightened paper clip, into the **RESET** hole on the back of the receiver, then remove it. The Clock 1 time display flashes (see "Setting the Clocks.")

## CONNECTING HEADPHONES

For private listening, you can connect an optional pair of headphones with a 3.5 mm (1/8-inch) plug to the receiver. Use monaural headphones.

Insert the headphones' plug into the **HEADPHONE** jack on the front of the receiver.



**Note:** Plugging in headphones automatically disconnects the internal speaker.

### Listening Safely

To protect your hearing, follow these guidelines when you use headphones.

- Set the volume to its lowest setting before you begin listening. After you put on the headphones, adjust the volume to a comfortable listening level.
- Do not listen at extremely high-volume levels. Extended high-volume listening can lead to permanent hearing loss.
- Once you establish a comfortable listening level, do not increase the volume.

Over time, your ears adapt to the volume level, so a volume level that does not cause discomfort might still damage your hearing.

## CONNECTING AN EXTERNAL SPEAKER

You can connect an optional external speaker with a 3.5 mm (1/8-inch) plug to the receiver. Use an 8-ohm external speaker capable of handling over 5 watts of power.

Insert the speaker cable's plug into the **EXT SPKR** jack on the back of the receiver.

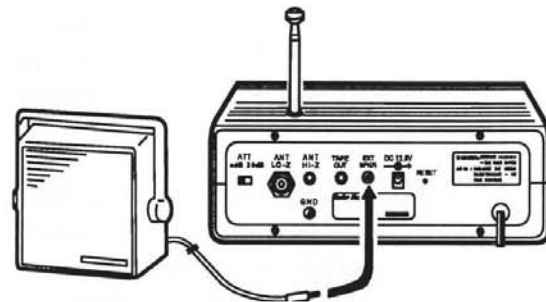

**Note:** Plugging in an external speaker automatically disconnects the receiver's internal speaker.

## CONNECTING A TAPE RECORDER

You can connect an optional tape recorder with a microphone jack to your receiver to record transmissions. To connect it, you need a connecting cable (not supplied) with a phono plug at one end.

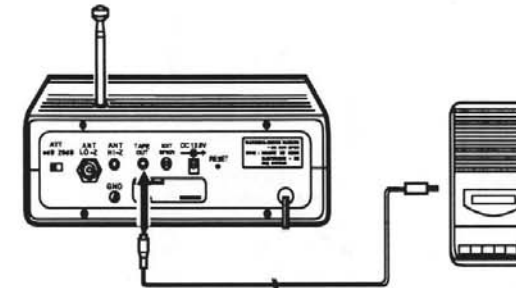

1. Insert the connecting cable's phono plug into the **TAPE OUT** jack on the back of the receiver.
2. Connect the other end of the connecting cable to your tape recorder's microphone jack.

Follow the instructions provided with your tape recorder to record transmissions from the receiver.

## UNDERSTANDING YOUR RECEIVER

### A LOOK AT THE CONTROLS

A quick glance at this section should help you understand each control's function.



**VOLUME** — adjusts the sound level.

**RF GAIN** — adjusts the receiver's sensitivity.

**MODE** — sets the receiving mode.

**FINE TUNE** — fine tunes the reception signal, especially when you tune to SSB and CW.

**Main Tuning Knob** — selects frequencies.

**STEP ▲, STEP ▼** — selects the 0.1, 1, 5, or 10 (9) kHz tuning frequency step sequentially.

**TIME SET** — sets the built-in clocks.

**SLEEP** — turns off the receiver after 30 or 60 minutes.

**DIMMER** — selects two levels of display back lighting brightness.

**POWER** — turns the power on and off.

**TIMER** — sets the built-in clocks and turns the timer on or off.

**NB** — turns noise blanker on and off.

**MON** — stores the current frequency into a monitor memory and recalls the frequency from memory.

**LOCK** — disables the main tuning knob and all buttons except **POWER** and **LOCK** to prevent accidental operation.

**LIMIT** — turns on the limit mode and sets the frequency range.

**BAND** — selects LW (150–509.9 kHz), MW (510–1729.9 kHz), or SW (1.73–29.9999 MHz) sequentially.

**METER** — selects one of the 13 International Broadcasting Bands.

**FREQ** — directly tunes to the frequency with number and decimal keys.

▲ and ▼ — tune up or down, select the higher or lower limit frequency in the limit mode, and the search direction in the limit, band, and meter modes.

**CLEAR** — clears an incorrect entry.

**PGM** — turns on the program mode to set a limit frequency, store a frequency or set the timer.

Each number key has a single digit printed on it and a meter band printed above it. Use the digits on the keys to enter the numbers for a frequency, a channel or a time setting. Use the meter band above the key (120m, for example) to select an International Broadcast Frequencies Band.

### A LOOK AT THE DISPLAY

The display has several indicators that show the receiver's current operating mode. A quick look at the display will help you understand how to operate your receiver.

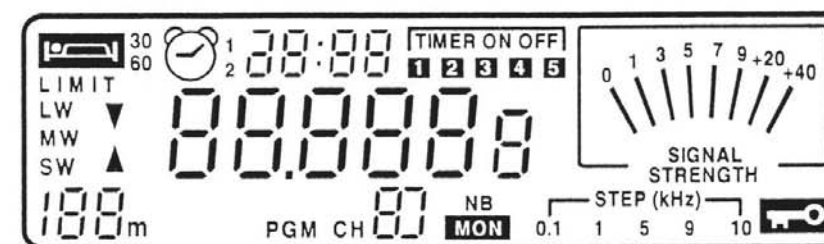

**30** **60** — appears when you set a 30- or 60-minute sleep timer.

**1** **2** — shows the time for two time zones.

**TIMER ON OFF** — the number from 1 to 5 under this indicator shows the timer condition and which timer is active.

**SIGNAL STRENGTH** meter — indicates signal strength.

**LIMIT** — appears when the receiver is in the limit frequency mode.

**LW, MW, and SW** — shows the band the receiver is currently tuned to: long wave (LW), medium wave (MW), or short wave (SW).

▲ or ▼ — appears when you set a limit frequency range or press ▲ or ▼.

. — enters a decimal point when you enter a frequency.

**ENT** — stores a frequency in a channel.

**Frequency indicator** — indicates your tuned frequency — from 150 kHz to 29.9999 MHz.

**m** — appears when a band meter is selected or a frequency is set.

**PGM** — the number to the right of this indicator shows the programmed channel number.

**NB** — appears when noise blanker is active.

**MON** — appears when the receiver is tuned to a monitor memory.

**STEP (kHz)** — appears with digits to show which frequency step (0.1, 1, 5, 9, or 10) the receiver is set to.

**LOCK** — appears when you turn on the lock function.

## RECEIVER OPERATION

- Turn **VOLUME** fully counterclockwise and **RF GAIN** fully clockwise before you turn on the receiver.
- Select the operation mode — **STANDBY, AM, LSB, USB, CW1, or CW2** (see “Using the Mode Control”).
- Press **POWER** to turn on the receiver.  
**Note:** If the clock display is flashing, set the time (see “Setting the Clocks”).
- Press **BAND** until the desired band (**LW, MW, or SW**) appears on the display (see “Selecting the Band”).
- Tune to the desired station (see “Tuning to a Station”).
- Adjust **VOLUME** as desired.
- Press **POWER** again to turn off the receiver.

### USING THE MODE CONTROL

The **MODE** switch setting determines the type of signal that your receiver receives. For standard broadcast and international short wave signals, use the **AM** position. For morse code, use **CW1** or **CW2**. For SSB signals, use the **LSB** or **USB** position. To help you decide whether to use **USB** (upper sideband) or **LSB** (lower sideband), see the following chart.

This chart shows the normal sideband mode used for the Ham bands.

(When receiving SSB on other bands, try both USB and LSB until you are able to identify the signal.)

Meters	Frequency (in MHz)	Sideband Used
160	1.8 to 2.0	Lower
80	3.5 to 4.0	Lower
40	7.0 to 7.3	Lower
20	14.0 to 14.35	Upper
17	18.068 to 18.168	Upper
15	21.0 to 21.45	Upper
12	24.89 to 24.99	Upper
10	28.0 to 29.7	Upper

#### Notes:

- If you tune through SSB signals while in the **AM** mode, you hear only fluttering sound. Switch to the **LSB** or **USB** mode.
- If you tune through AM signals while using the **LSB** or **USB** mode, you hear a very annoying background tone, which varies with the setting of the tuning controls. If this happens, switch to the **AM** mode.
- Setting **MODE** to the **STAND BY** position prevents you from changing the main tuning knob and all buttons, except **POWER**. This position also turns off the sound.

## SELECTING THE BAND

To select the long wave (LW), medium wave (MW), or short wave (SW) band, press **BAND** until the desired band appears on the display.

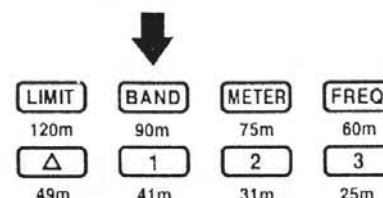

### Selecting the International Radio Frequency Band

- Press **METER** to display the current meter band.
- Press **METER** again if you want to change the meter band. The meter band flashes for 10 seconds.
- While the meter band flashes, press the desired meter band key. For example, to select the 90 meter band, press **90m**.

### SETTING A LIMIT TUNING RANGE

You can set a frequency range so you can tune to frequencies between lower and upper limits.

- Press **LIMIT**. **LIMIT** appears on the display.
- Press **PGM**. **▲** flashes for about 10 seconds.

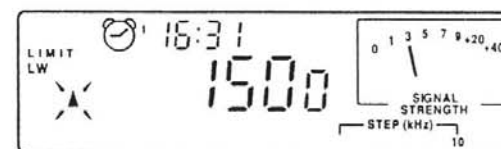

- Enter the lower limit of the frequency range including the decimal point.
  - To set 150 kHz, enter 150.
  - To set 1 MHz, enter 1000 or 1.
  - To set 10 MHz, enter 10000 or 10.

#### Notes:

- If you try to enter invalid frequency (100, for example), **Error** appears on the display. Press **CLEAR** or wait 5 seconds until **Error** disappears from the display.
  - You cannot use the main tuning knob to set a limit tuning range.
- Press **LIMIT**. **▼** flashes for about 10 seconds.

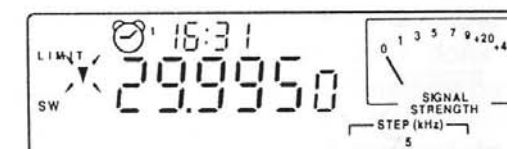

- Enter the upper limit of the frequency range including the decimal point.
- Press **ENT**.
- Press **▲** or **▼** to search through the frequencies in the selected band.

#### Notes:

- If you make a mistake in Step 3 or 5, press **CLEAR** to erase the last digit.
- If you wait more than 10 seconds to press a key. You must begin again at Step 2.
- To return to the previous mode, press **LIMIT** until **LIMIT** disappears from the display. The limit tuning range is stored in memory until you set a new range.



## TUNING TO A STATION

You can tune to a desired broadcast station using the manual, direct access, search, or memory tuning methods. Use the lower keypad or main tuning knob to tune broadcasts.

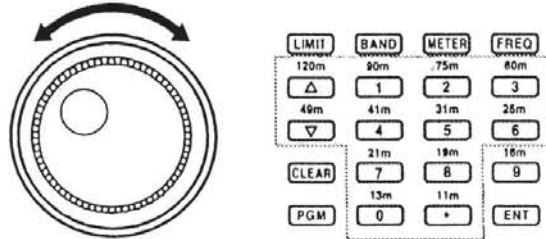

### Manual Tuning

To manually tune to a frequency, repeatedly press ▲ or ▼ or rotate the main tuning knob until the display shows the desired frequency.

### Direct Access Tuning

1. Press **FREQ**. The frequency display flashes for about 10 seconds.
2. While the frequency display flashes, press the number keys, including the decimal key, to select the desired station's frequency.
3. Press **ENT**.

#### Notes:

- If you make a mistake, press **CLEAR** to erase the last digit.
- If you do not press a key for more than 10 seconds, the display stops flashing. Start again from Step 1.
- If you try to enter an invalid frequency, **Error** appears on the display. Press **CLEAR** or wait 5 seconds until **Error** disappears from the display.

- Your receiver automatically rounds down the entered frequency to the nearest valid frequency. For example, if you try to enter a frequency of 478 in LW, your receiver accepts it as 470 (when the frequency step is set to 10 kHz — see "Setting the Frequency Step").

### Search Tuning

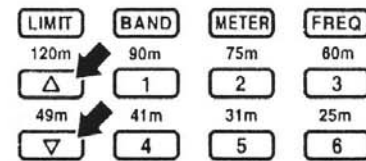

To automatically tune up or down to the next frequency in the selected LW, MW, SW band, 13 international broadcast band (meter), or limit frequency band, press and hold down ▲ or ▼ for about 2 seconds. The receiver searches up or down in the selected band and tunes to the first frequency it finds with a strong signal.

#### Notes:

- To tune to stations with weaker signals, use one of the manual tuning methods.
- If the **RF GAIN** is set fully clockwise, the receiver might not search up or down when you press ▲ or ▼. Turn the **RF GAIN** control counterclockwise.

Press ▲ or ▼ for about 2 seconds to restart the search.

## Memory Tuning

For easy selection, you can store the frequencies of your favorite stations into memory channels. You can store up to 160 frequencies — 10 frequencies each in the LW, MW, SW bands, and 10 in each of the meter bands.

Follow these steps to store a frequency into memory.

1. Select the band or meter.
2. Use direct access or manual tuning to tune to the frequency you want to store.

**Note:** When you store frequencies in the SW band and the meter bands, the frequencies are stored in either the SW band's channel memory or the meter bands' channel memory depending on the tuning method. When a frequency (for example: 3.200000 MHz, 90m) is tuned by direct tuning (using **FREQ**), the frequency is stored in the SW band's channel memory. When the same frequency is tuned by manual tuning (using the tuning control or ▲ or ▼), the frequency is stored in the 90m band's channel memory.

3. Press **PGM**.



4. While **PGM CH** flashes, enter a memory channel number from 1–10 (press 0 for 10).

5. While **PGM CH** and the memory channel number flash, press **ENT** to store the frequency.

**Note:** If you wait more than 10 seconds to press **ENT**, you must begin again from Step 3.

6. To store more frequencies in the same band, repeat Steps 2–5. To store a frequency from another band, repeat Steps 1–5.

To tune to the desired memory channel, select the band and then press the channel number.

## USING A MONITOR MEMORY

The receiver's monitor memory is a temporary storage area where you can store a frequency while you decide whether or not to save it in a channel.

1. Press **MON** while the desired frequency is displayed. **MON** and any previously stored frequency appear on the display.
2. Press **ENT**. The new frequency replaces the old one in the monitor memory.

To listen to the monitor memory, press **MON**.

## USING THE RF GAIN CONTROL

When you receive an extremely strong signal, turn **RF GAIN** to vary the overall volume, instead of using the **VOLUME** control.

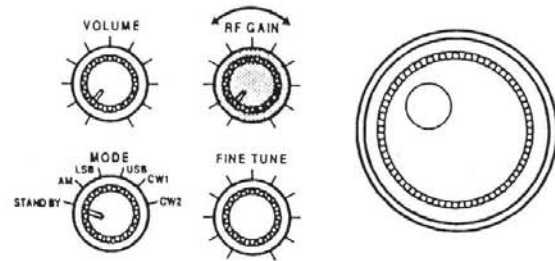

## USING THE FINE TUNE CONTROL

To receive SSB clearly, adjust **FINE TUNE** very slowly and carefully until the voice sounds normal. When improperly tuned, voices have a low guttural sound or sound like "Donald Duck." SSB signal tuning takes patience and practice.

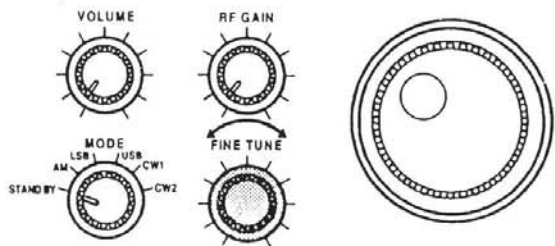

If you are listening to a morse code signal, adjust **FINE TUNE** for the pitch of tone which best suits you.

**Note:** In the Ham bands, most of the activity is in code or SSB.

## SETTING THE FREQUENCY STEP

Station frequencies are generally assigned in standard tuning increments to reduce broadcast interference. Your receiver is preset to change and search for frequencies in the standard, conventional increments. However, your receiver has the capability to change the frequency step for easier, incremental tuning, or increased search capability. The following table shows the default tuning steps.

Band	Tuning Increment
LW	10 kHz
MW	10 kHz (See "Changing the MW Tuning Increment.")
SW	5 kHz
HAM	1 kHz

Press **STEP ▲** or **STEP ▼** to select your desired tuning step. As you press **STEP ▲** or **STEP ▼**, the frequency step appears under **STEP (kHz)** on the display in this order: 0.1, 1, 5, 10(9).

## CHANGING THE MW TUNING INCREMENT

In the United States, the MW band frequencies step in 10 kHz increments. In some countries, the MW band frequencies step in 9 kHz increments. Your receiver has the capability to shift between these two step increments. Here is how to change the step.

1. Press **POWER** to turn off the receiver.
2. While pressing **STEP ▲** or **STEP ▼**, press **POWER**.

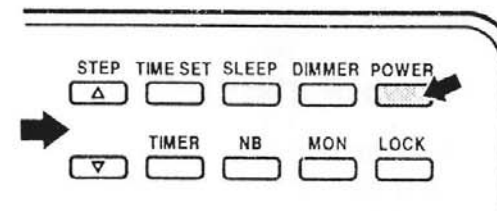

The 10 kHz step is changed to 9 kHz or vice versa. If you want to change it back, repeat the procedure.

## USING THE DIMMER BUTTON

To light up the display, press the **DIMMER** button. To turn off the lighting, press the **DIMMER** button again.

## USING THE LOCK BUTTON

To prevent accidental frequency changes, press the **LOCK** button. This prevents you from changing main tuning knob and all buttons, except **POWER** and **LOCK**. To unlock the controls, press the **LOCK** button again.

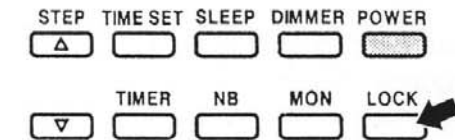

## USING THE ATT SWITCH

To reduce interference or noise caused by signals from a strong local broadcaster, you can reduce the receiver's sensitivity by setting the **ATT** (attenuate) switch on the back of the receiver.

Switch **ATT** to **20 dB** to reduce the receiver's sensitivity, or **0 dB** for normal sensitivity.

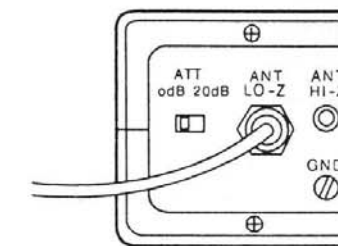

### Notes:

- If you switch **ATT** to **20 dB**, your receiver might not receive weak signals.
- The **ATT** switch affects only the antenna connected to the **ANT LO-Z** terminal.

# CLOCK RADIO OPERATION

## SETTING THE CLOCKS

Your receiver has two clocks. We recommend you set the primary clock to the local time and the secondary clock to the UTC (Coordinated Universal Time — also called Greenwich Mean Time).

**Note:** The receiver's time display uses the 24-hour format.

1. Press and hold down **TIME SET** for 2 seconds.  is selected and the time digits flash on the display.



2. While the clock display flashes, use the number keys to enter the correct time. For example, enter **930** for 9:30.

**Note:** If you make a mistake, press **CLEAR** to erase the last digit.

3. Press **TIME SET** to select . The hour digit flashes.



4. While the hour digit flashes, use the number keys to enter the hour for the second clock.



**Note:** You only need to enter the hour. For example, enter **4** for 4:30. The minutes change automatically according to the primary clock setting.

5. Press **ENT** to start both clock 1 and clock 2. The colon flashes.



Press **TIME SET** to alternate between the time on clock 1 and clock 2.

## USING THE TIMERS

Your receiver has five programmable timers. You can store a tuning frequency and on/off times into each timer. When you turn on a timer, the receiver automatically turns on and tunes to the programmed frequency when the timer reaches the programmed time. When it reaches the off time, the receiver turns off.

**Note:** The timers are set to Clock 1.

### Programming a Timer

1. Set the frequency that you want the receiver to tune to when it turns on.

For example, set 12.345 MHz.



2. Press **TIMER**.



3. Within 10 seconds, enter the desired timer memory number (1 to 5). (For example, press **1** to select timer memory 1.) The memory number flashes and the previously programmed frequency or **0.0000** appears.



4. Press **PGM** to select the timer memory. The band indicator and frequency flash.



5. To change the times, press **TIMER**. The time digits flash on the display.



6. Enter the time when you want the receiver to turn on. For example, enter **15:30**.

**Note:** If you want to set only the off time, press **CLEAR**.



7. Press **TIMER**. The time digits flash on the display.



8. Enter the time when you want the receiver to turn off. For example, enter **16:00**.

**Note:** If you do not want to set the off time, press **CLEAR**.



9. Press **ENT** to store the settings.





## Turning on a Timer

1. Press **TIMER**.



2. Enter the timer memory number (for example, enter 1). The selected memory number flashes.



3. Press **ENT**.
4. If you want to turn on more timers, repeat Steps 1-3.
5. Press **POWER** to turn off the receiver.

## Clearing a Timer



If the receiver is off:

1. Press **POWER** to turn on the receiver.
2. Press **TIMER**.
3. Enter the timer memory number.
4. Press **CLEAR**.

If the receiver has already turned on automatically, press **POWER**. The timer program is canceled and the receiver turns off.

## USING THE SLEEP TIMER

The sleep timer sets the receiver to turn off after a set time (30 or 60 minutes) so you can fall asleep as you listen to the receiver.

Press **SLEEP** until the desired time appears -  or .



To turn off the receiver before it automatically turns off, press **POWER**.

To turn off the sleep timer, press **SLEEP** until the indicator disappears.

## LISTENING HINTS

Short wave listening is a hobby with millions of participants worldwide. It requires no special knowledge or skills, but your enjoyment increases as you gain experience and develop special listening techniques.

The information in this section can help you make the most of your listening time.

## REFERENCE SOURCES

Many books and magazines about short wave listening are available through your local library or newsstand. See sources such as "The World Radio Handbook," "Radio Amateur's Handbook," "Passport to World Band Radio," "Monitoring Times," and "Popular Communications." These publications can help you learn about the conditions that make long-distance reception possible and provide up-to-date listings for short wave broadcasts in English and other languages.

## BAND ALLOCATION

Certain portions of the radio spectrum are set aside for specific purposes.

**Note:** Bands are often referred to by wavelength. For example, the 19-meter band refers to the range of frequencies with waves about 19 meters long.

## Ham Frequencies

Tuning to the ham radio frequencies can be interesting and helpful, because ham operators often communicate emergency information when other means of communication break down.

Ham radio operators use the following bands. Portions of these bands are set aside for continuous wave (CW) morse code communication or for single side-band (SSB) voice communication, as shown below.

### 160 meters:

1,800–2,000 kHz: CW, LSB

### 80 meters:

3.500–3.750 MHz: CW  
3.750–4.000 MHz: LSB

### 40 meters:

7.000–7.150 MHz: CW  
7.150–7.300 MHz: LSB

### 20 meters:

14.000–14.150 MHz: CW  
14.150–14.350 MHz: USB

### 17 meters:

18.068–18.110 MHz: CW  
18.110–18.168 MHz: USB

### 15 meters:

21.000–21.200 MHz: CW  
21.200–21.450 MHz: USB

### 12 meters:

24.890–24.930 MHz: CW  
24.930–24.990 MHz: USB

### 10 meters:

28.000–28.300 MHz: CW  
28.300–29.700 MHz: USB

**Note:** These ranges are not precisely observed everywhere in the world.



## Birdie Frequencies

Every receiver has birdie frequencies. Birdies are operating frequencies created inside the receiver. These operating frequencies might interfere with broadcasts on the same frequencies. If you receive one of these frequencies, you hear only noise on that frequency.

Here are the birdie frequencies to watch for on this receiver:

150 – 180 kHz in all modes.

451.5, 903, and 1354.5 kHz in the LSB and CW1 modes.

458.5, 917, and 1375.5 kHz in the USB and CW2 modes.

## International Broadcast Frequencies

International Commercial Broadcasts are found in the following SW bands. These programs (often in English) usually contain news, commentaries, music, and special features reflecting the culture of the broadcasting country. You might find it easiest to hear these broadcasts between 6:00 PM and midnight (your time).

**Note:** Use the AM mode to receive international short wave signals.

Band (in meters)	Frequency Range (in MHz)
120*	2.300–2.495
90*	3.200–3.400
75**	3.900–4.000
60*	4.750–5.060
49	5.950–6.200
41**	7.100–7.300
31	9.500–9.900
25	11.650–12.050
21	13.600–13.800
19	15.100–15.600
16	17.550–17.900
13	21.450–21.850
11	25.670–26.100

\* These bands are reserved for stations in tropical areas.

\*\* Ham operators and international stations share 3.900–4.000 MHz and 7.100–7.300 MHz. Interference is heavy in this range.

## Aircraft Frequencies

Most transmissions are in SSB, although you can still hear some AM transmissions. Aircraft on international routes sometimes use SW. Here are some ranges where you might hear aircraft communications.

**Note:** Try to receive primarily in the USB mode, but you can try LSB and AM, also.

4.650–4.750 MHz  
6.545–6.765 MHz  
8.815–9.040 MHz  
10.000–10.100 MHz  
11.175–11.400 MHz  
13.200–13.360 MHz  
15.010–15.100 MHz  
17.900–18.030 MHz

## Ships and Coastal Stations

Most transmissions from ships and coastal stations are in USB and CW. You can hear these transmissions in the following bands.

**Note:** Try to receive primarily in the USB mode, but you can try LSB and AM, also.

2.000–2.0 MHz\*  
4.063–4.139 MHz  
4.361–4.438 MHz  
8.195–8.181 MHz  
12.330–12.420 MHz  
13.107–13.200 MHz  
16.460–16.565 MHz

\* The Coast Guard and small boats use this band, with 2.182 MHz set aside as the international distress and emergency channel.

## Time Standard Frequencies

The following frequencies announce the exact time of day at specified intervals.

WWV in Fort Collins, Colorado:

2.500 MHz  
5.000 MHz  
10.000 MHz  
15.000 MHz  
20.000 MHz

CHU in Canada: 7.335 MHz

VNG in Australia: 4.500 and 12.000 MHz

## Long Wave Band

The 150–509.9 kHz range is known as the long wave band. Most stations in this range serve as beacons for aircraft and marine navigation by continuously transmitting their call letters. Through your local library, you can find books on air and marine navigation, which contain lists of the beacon stations and their locations. Reception for this range is best between 6:00 PM and midnight (your time).

Some ships also use this range, with 500 kHz set aside as an international distress and emergency station.

Most stations in this range use CW (Morse code), although some use AM voice transmission for weather broadcasts.

## FREQUENCY CONVERSION

The tuning location of a station can be expressed in frequency (kHz or MHz) or in wavelength (meters). The following information can help you make the necessary conversions.

To convert from MHz to kHz, multiply by 1,000. For example:

$$9.62 \times 1,000 = 9,620 \text{ kHz}$$

To convert from kHz to MHz, divide by 1,000. For example:

$$2780 \text{ kHz} \div 1000 = 2.78 \text{ MHz}$$

To convert from MHz to meters, divide 300 by the number of MHz. For example:

$$300 \div 7.3 = 41 \text{ meters}$$

## TROUBLESHOOTING

Your DX-394 Communications Receiver should require very little maintenance. If you have problems, refer to this chart for possible solutions.

Problem	Probable Cause	Solution
Receiver is totally inoperative.	The AC plug is not properly connected.	Check to see that the receiver is plugged into a working AC outlet.
	The optional DC power cable is not properly connected.	Check to be sure the power cable is fully inserted into the <b>DC 13.8V</b> jack and cigarette lighter.
Poor or no reception.	Improperly connected antenna.	Check to be sure the antenna is properly connected.
	Poor reception on SW band.	Try to receive between 6:00 PM and midnight.
	Poor reception on LW, MW, and SW band.	Move the receiver to a location with better reception.
	Incorrectly programmed frequencies.	Reprogram the frequencies correctly.
<b>Error</b> appears on the display.	Programming error.	Reprogram the frequencies.
Keys do not work or display changes at random.	Undetermined error.	Reset the receiver (see "Resetting the Receiver").
	The <b>MODE</b> selector is set to <b>STAND BY</b> .	Set the <b>MODE</b> selector to the desired mode.
Search stops where there is no clear signals.	Birdies.	Using an outdoor antenna might reduce these signal. See "Birdies".
<b>ROTARY TUNING</b> and front panel keys do not respond.	The lock function is activated.	Press <b>LOCK</b> to unlock the operation.

If you cannot solve the problem, contact your local Radio Shack/Tandy store for assistance.

## CARE AND MAINTENANCE

Your Radio Shack DX-394 Communications Receiver is an example of superior design and craftsmanship. The following suggestions will help you care for your receiver so you can enjoy it for years.



Keep the receiver dry. If it gets wet, wipe it dry immediately. Liquids can contain minerals that can corrode the electronic circuits.



Handle the receiver gently and carefully. Dropping it can damage circuit boards and cases and can cause the receiver to work improperly.



Use and store the receiver only in normal temperature environments. Temperature extremes can shorten the life of electronic devices, damage batteries, and distort or melt plastic parts.



Keep the receiver away from dust and dirt, which can cause premature wear of parts.



Wipe the receiver with a damp cloth occasionally to keep it looking new. Do not use harsh chemicals, cleaning solvents, or strong detergents to clean the receiver.

Modifying or tampering with your receiver's internal components can cause a malfunction and might invalidate the receiver's warranty and void the unit's legal certification to operate. If your receiver is not operating as it should, take it to your local Radio Shack/Tandy store for assistance.

## SPECIFICATIONS

### Frequency Coverage:

LW .....	150–509.9 kHz
MW .....	510–1729.9 kHz
SW .....	1.73–29.9999 MHz

### SW Sub-Bands:

2.300–2.495 MHz (120 meters); 3.200–3.400 MHz (90 meters); 3.900–4.000 MHz (75 meters); 4.750–5.060 MHz (60 meters); 5.950–6.200 MHz (49 meters); 7.100–7.300 MHz (41 meters); 9.500–9.900 MHz (31 meters); 11.650–12.050 MHz (25 meters); 13.600–13.800 MHz (21 meters); 15.100–15.600 MHz (19 meters); 17.550–17.900 MHz (16 meters); 21.450–21,850 MHz (13 meters); 25.670–26.100 MHz (11 meters)

### Sensitivity: (AM 10 dB (S+N)/N at 30% modulation)

LW .....	10 $\mu$ V
MW .....	7 $\mu$ V
SW .....	1 $\mu$ V

### (SSB 10 dB (S+N)/N)

SW .....	0.3 $\mu$ V
----------	-------------

### (CW 10 dB (S+N)/N)

SW .....	0.1 $\mu$ V
----------	-------------

### Selectivity:

$\pm 7$ kHz (AM) .....	50 dB
15 kHz (SSB/CW) .....	50 dB

IF Rejection (Lo-Z) ..... 80 dB

Spurious Rejection (Lo-Z) ..... 80 dB

### IF Frequency:

1st .....	45 MHz
2nd .....	455 kHz

### Antenna Impedance:

Lo-Z .....	50 ohms
Hi-Z .....	2 kohms

Audio Output Power (10% THD) ..... 800 mW

Built-in Speaker ..... 77 mm (3") 8-ohm dynamic type

Power Requirement ..... AC 120 volts, 60 Hz, 13 watts  
DC 13.8 volts, 8 watts

Operating Temperature ..... 0 C to 43 C (32 F to 109 F)

Dimensions ..... 96 x 233 x 230 mm  
(3 11/16 x 9 3/16 x 9 inches)

Weight ..... 2.1 kg (4.6 lbs)

Specifications are typical; individual units might vary. Specifications are subject to change and improvement without notice.